



Sterling Couch Range



Therapy Couch Range



Patient Trolley Range

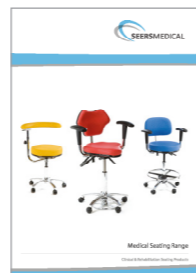

Seating Range



SEERS MEDICAL Ltd
Kenton Road,
Debenham, Suffolk
IP14 6LA, United Kingdom
© Copyright SEERS Medical Ltd 2022

Company Reg. N° 6572698
VAT N° 931596702
Printed in the United Kingdom

Note¹: The illustrated fabric colours may vary slightly from actual fabric supplied. This occurs due to the four colour printing process. However every attempt has been made to make them as accurate as possible. Our Policy of continuous improvement means that we reserve the right to change and modify designs without prior notice. Note²: Measurements may vary +/- 2° or +/- 5mm due to manufacturing tolerances



Tel +44 (0)1728 861 590
Fax +44 (0)1728 861 868

info@seersmedical.com
www.seersmedical.com

Issue N° 8/22
Part N° 06Z-8005-SF

Clinical Range

Clinical Couches for Patient Examination and Minor Treatment Procedures

Introduction

In this new brochure we cover our wide range of patient examination furniture for various medical procedures such as Gynaecology, Ultrasound, Phlebotomy, Lymphoedema and Podiatry. There is a wide choice of models and accessories to cater for various examination procedures as well as specialist treatment and minor operation techniques. Most models are variable in height with a choice of both manual or electric positioning and height operation. The development of these products has been achieved by applying our many years of experience and knowledge in this market. Much thought has been given to the design, to benefit both the comfort and security of the patients as well as providing manual handling solutions which promote good posture and ergonomics to all clinical staff when they are using this equipment. With the management and control of our own assembly line at our premises in Debenham, Suffolk in the UK, our couches comply to the CE medical devices directive 93/42/EEC, ensuring we supply high quality products every time, with short lead times to meet the tightest of deadlines. We trust you will experience this yourself when you purchase a SEERS Medical product. **SEERS Medical are ISO9001 and ISO14001 accredited.**

Contents

4-5	Medicare 2 Section Couch
6-7	Medicare 3 Section Couch
8-9	Medicare Mobile 2 Section Couch
10-11	Medicare Mobile 3 Section Couch
12-13	Innovation Deluxe 2 Section Couch
14-15	Innovation Deluxe 3 Section Couch
16-17	Innovation Deluxe Daycare Couch
18-19	Innovation Deluxe Dialysis Couch
20-21	Medicare Multi-Couch - Single Footrest
22-23	Medicare Podiatry Couch
24-25	Medicare Orthopaedic Couch
26-27	Medicare Phlebotomy Couch
28-29	Medicare Echocardiography Couch
30-31	Medicare Ultrasound Couch
32-33	Medicare Gynaecology Couch
34-35	Medicare Deluxe Gynaecology Couch
36-37	Medicare GP Gynaecology Couch
38-39	Medicare Bariatric 2 Section Couch
40-41	Medicare Bariatric 3 Section Couch
42-43	Medicare Bariatric Drop End Couch
44-45	Shower Trolley
46-47	Optional Accessories
48-49	Chairs, Stools & Vinyl Colour Options



Safe working load
240Kg (550lbs)



Mobile hoist clearance
beneath frame



Anti-bacterial
powder coated frame



Anti-microbial
vinyl upholstery



Crib 5
Fire retardant upholstery



Low patient
transfer height



Complies with EC
Directive 93/42/EEC

Technical Information

At SEERS Medical we are using state of the art design tools, such as 3D solid modelling and in house rapid prototyping, to assist us in getting new designs into development and manufacture. Whilst designing new products, all manufacturing capabilities available are taken into consideration, such as CNC wood cutting, laser profiling and robot welding, which deliver reliable build quality and repeatability of accurate components, time after time. A typical innovative use of these processes is evident in a high loaded components such as the ram bracket, a common item on many SEERS couches, where using laser profiling we have been able to make the parts interlock, adding immense strength, even before welding! This is typical of the attention to detail that we pride ourselves with, and sets us apart from other couch manufacturers, giving us confidence in the reliability and longevity of the products we manufacture.

Mechanical Safety & Load Testing

All SEERS Medical products have been tested to the applicable EN 60601-1:2006+A12:2014 (E) the General requirements for basic safety and essential performance. Our couches have been thoroughly tested with a two and a half times safe working load (in excess of 600Kg loaded evenly, for in excess of one hour, to prove load support capability without failure. Our products are tested in accordance to Clauses 9.8.3.2-3 Static Forces of EN60601-1:2006 Not only do our products have high safe working loads (typically 240Kg), but our products also lift the rated safe working load from the minimum height to the maximum height smoothly.

Electrical Safety

All SEERS Medical products comply to EN 60601-1:2006+A12:2014 (E) the General requirements for basic safety and essential performance. In addition, the actuation and control systems used on our products are marked with the UL mark, demonstrating compliance to UL60601-1 and CAN/CSA-C22.2 No. 601.1-M90, meeting the requirements for USA and Canada. The actuation control system is also marked with approval to C-ETL-US No. 3154358.

CE Marking & Quality System

SEERS Medical operates a Quality Management System in accredited and approved to ISO 13485:2016. SEERS Medical products comply with the Essential Requirements in Annex I of EC Directive 93/42/EC, with all relevant design, production records, risk assessments, product testing and labelling information recorded in the documentation file labelled the "Technical File". All products carry a unique serial number for trace-ability of build date, model number and associated build records.

Flammability

The upholstered couch sections satisfies flammability requirements to the standards of BS 7176:1995 (medium hazard) using ignition sources 0 (cigarette), 1 (gas) as defined in BS EN. 1921-1 and 2 and 5 (crib) BS 5852:1990.

Warranty

The variable height couches detailed in this brochure have a lifetime frame warranty and five years warranty on all other components.

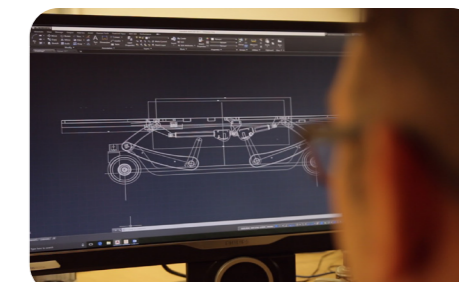

CAD design technology

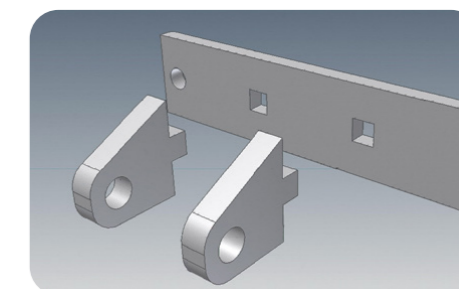

Interlocking structural components

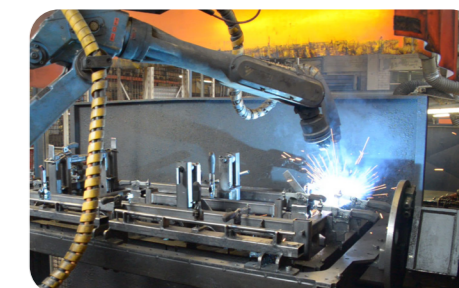

Laser profiling

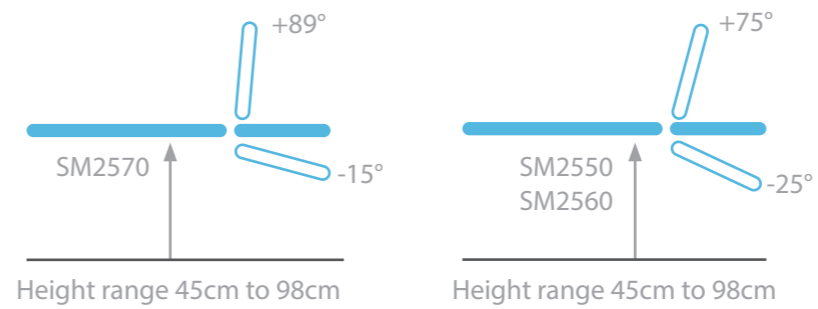

Medicare 2 Section Couch



A very strong and rigid couch available with a wide range of accessories. Suitable for supporting very heavy patients for examination and minor treatment procedures.

Models

- SM2550** Hydraulic with gas assisted backrest
- SM2560** Electric with gas assisted backrest
- SM2570** Electric with electric backrest



Model SM2560
Colour Sky Blue

Standard Features

- Safe working load and lifting capacity of 240Kg (528lbs)
- Gas assisted backrest adjustable from -25° to 75° on SM2550 and SM2560 and incorporates anti-trap design
- Electric backrest adjustable from -15° to 89° on SM2570
- Choice of hydraulic or electric height elevation
- Excellent height range from 45cm to 98cm
- Retractable wheel design with adjustable foot for stability
- Purpose made precision bearings on all pivot points
- Clearance beneath frame for mobile hoist
- Hand switch fitted as standard on electric models
- Frames pre-drilled for addition of accessories
- Anti-bacterial powder coated frame
- 63cm wide Easy Clean Upholstery as standard
- Choice of Standard or Standard+ upholstery colours

Optional Accessories

- 9002** Side support rails (Pair)
- 9002P** Side support cushions (Pair)
- 6004** Breathing hole and plug
- 6005** Paper roll holder
- 6006** Upper limb support
- 6007** Removable head/knee support
- 6053** Protective base frame cover
- 6054** Telescopic IV pole
- 6057** Battery back-up facility
- EPFS** Perimeter Foot Switch for SM2560
- 1WF** Single foot switch for SM2560
- 2WF** Double foot switch for SM2570
- 9200/70** 70cm Width Easy Clean Upholstery



Low patient transfer height



Negative head section to -25°

Available Upholstery Colours:

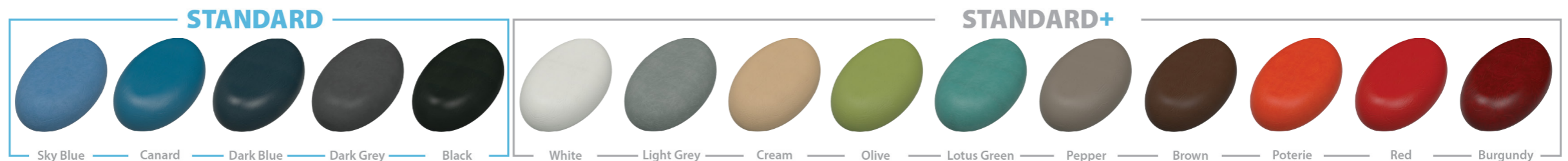

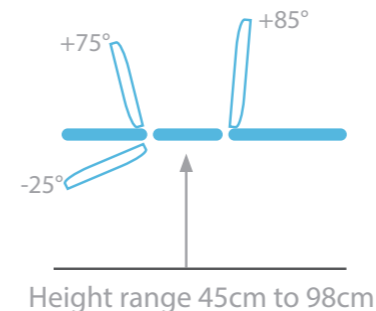

63	60	43	91	Standard Dimensions
	70*	65	43	

*When fitted with 9300/70 Easy Clean Upholstery

Medicare 3 Section Couch



The Medicare 3 Section Couch provides a very stable and versatile support surface for prone, supine and seated treatment procedures and examinations. Both the elevating sections can be set to a wide range of angles for specific patient positioning.

Models

- SM3550** Hydraulic with gas assisted backrest
- SM3560** Electric with gas assisted backrest
- SM3570** Electric with electric backrest



Model SM3560 Colour cream

Standard Features

- Safe working load and lifting capacity of 240Kg (528lbs)
- Gas assisted or electric backrest adjustable from 0° to +85°
- Gas assisted head section adjustable from -25° to +75°
- Gas assisted sections incorporate anti-trap design
- Choice of hydraulic or electric height elevation
- Excellent height range from 45cm to 98cm
- Retractable wheel design with adjustable foot for stability
- Purpose made precision bearings on all pivot points
- Clearance beneath frame for mobile hoist
- Hand switch fitted as standard on electric models
- Frames pre-drilled for addition of accessories
- Anti-bacterial powder coated frame
- 63cm wide Easy Clean Upholstery as standard
- Choice of Standard or Standard+ upholstery colours

Optional Accessories

- 9003** Side support rails (Pair)
- 9002P** Side support cushions (Pair)
- 6004** Breathing hole and plug
- 6005** Paper roll holder
- 6006** Upper limb support
- 6007** Removable head/knee support
- 6053** Protective base frame cover
- 6054** Telescopic IV pole
- 6057** Battery back-up facility
- EPFS** Perimeter Foot Switch for SM3560
- 1WF** Single foot switch for SM3560
- 2WF** Double foot switch for SM3570
- 9300/70** 70cm Width Easy Clean Upholstery



Negative head/ foot section to -25°



Low patient transfer height

Available Upholstery Colours:

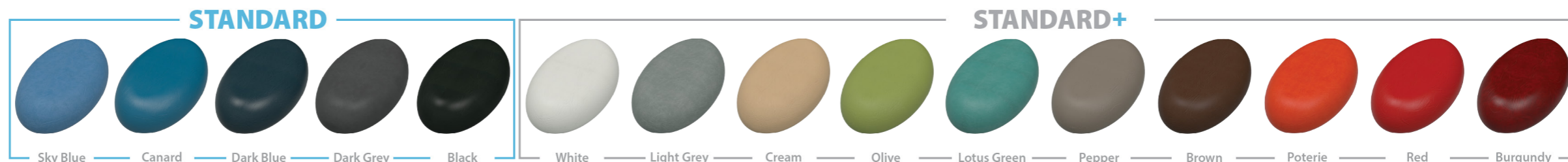

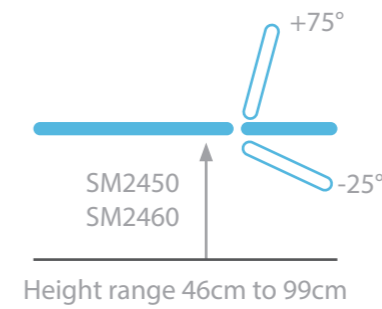
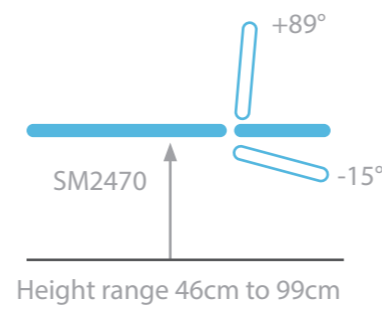

63	125	70	Standard Dimensions
70*	130	65	*When fitted with 9200/70 Easy Clean Upholstery

Medicare Mobile 2 Section Couch



Very strong and rigid 2 section mobile treatment couches supplied with side support rails and a paper roll holder. The large wheel system incorporates a steering facility and the couches have excellent height ranges with a low patient transfer height of just 46cm.

Models

Independently Braking Castors (IBC)

- SM2450** Hydraulic with gas assisted backrest
- SM2460** Electric with gas assisted backrest
- SM2470** Electric with electric backrest

Central Locking Castors (LMWD)

- SM2650** Hydraulic with gas assisted backrest
- SM2660** Electric with gas assisted backrest
- SM2670** Electric with electric backrest



Model SM2650
Shown with optional 6053 Base Cover, 9002P Side Cushions,
6054 IV Pole and 6007 Head Cushion
Colour Sky Blue

Standard Features

- Safe working load and lifting capacity of 240Kg (528lbs)
- Gas assisted backrest adjustable from -25° to 75° on SM2450, SM2460, SM2650 and SM2660
- Electric backrest adjustable from -15° to 89° on SM2470/2670
- Gas assisted backrest incorporates anti-trap design
- Choice of hydraulic or electric height elevation
- Excellent height range from 46cm to 99cm
- Side Rails & Paper Roll Holder fitted as standard
- Choice of independently or centrally locking castors
- Purpose made precision bearings on all pivot points
- Clearance beneath frame for mobile hoist
- Hand switch fitted as standard on electric models
- Frames pre-drilled for addition of accessories
- Anti-bacterial powder coated frame
- 63cm wide Easy Clean Upholstery as standard
- Choice of Standard or Standard+ upholstery colours

Optional Accessories

- 9002P** Side support cushions (Pair)
- 6004** Breathing hole and plug
- 6006** Upper limb support
- 6007** Removable head/knee support
- 6053** Protective base frame cover
- 6054** Telescopic IV pole
- 6057** Battery back-up facility
- 1WF** Single foot switch for SM2X60
- 2WF** Double foot switch for SM2X70
- 9200/70** 70cm Width Easy Clean Upholstery



Low patient transfer height
Shown with optional 6053 Base Cover



Seated position
Shown with optional 6053 Base Cover and
6006 Upper Limb Support

Available Upholstery Colours:

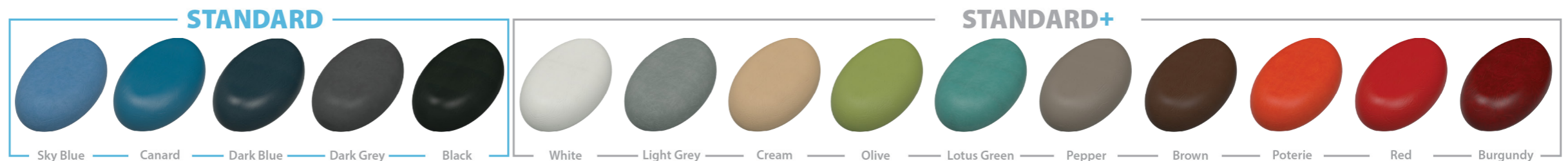

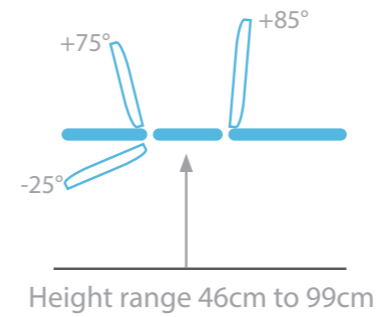

63	60	43	91	Standard Dimensions
70*	65	43	86	*When fitted with 9300/70 Easy Clean Upholstery

Medicare Mobile 3 Section Couch



Very strong and rigid 3 section mobile treatment couches supplied with side support rails and a paper roll holder as standard. The Large Mobile Wheel Design incorporates central locking castors & steering facility, and the couches have excellent height ranges with a low patient transfer height.

Models

- Independently Braking Castors (IBC)**
SM3450 Hydraulic with gas assisted backrest
SM3460 Electric with gas assisted backrest
SM3470 Electric with electric backrest
- Central Locking Castors (LMWD)**
SM3650 Hydraulic with gas assisted backrest
SM3660 Electric with gas assisted backrest
SM3670 Electric with electric backrest



Model SM3650
Colour Sky Blue

Standard Features

- Safe working load and lifting capacity of 240Kg (528lbs)
- Gas assisted or electric backrest adjustable from 0° to +85°
- Gas assisted head section adjustable from -25° to +75°
- Gas assisted sections incorporate anti-trap design
- Choice of hydraulic or electric height elevation
- Excellent height range from 46cm to 99cm
- Choice of independently or centrally locking castors
- Side Rails & Paper Roll Holder fitted as standard
- Purpose made precision bearings on all pivot points
- Clearance beneath frame for mobile hoist
- Hand switch fitted as standard on electric models
- Frames pre-drilled for addition of accessories
- Anti-bacterial powder coated frame
- 63cm wide Easy Clean Upholstery as standard
- Choice of Standard or Standard+ upholstery colours

Optional Accessories

- 9002P** Side support cushions (Pair)
- 6004** Breathing hole and plug
- 6006** Upper limb support
- 6007** Removable head/knee support
- 6053** Protective base frame cover
- 6054** Telescopic IV pole
- 6057** Battery back-up facility
- 1WF** Single foot switch for SM3X60
- 2WF** Double foot switch for SM3X70
- 9300/70** 70cm Width Easy Clean Upholstery



Low patient transfer height

Available Upholstery Colours:

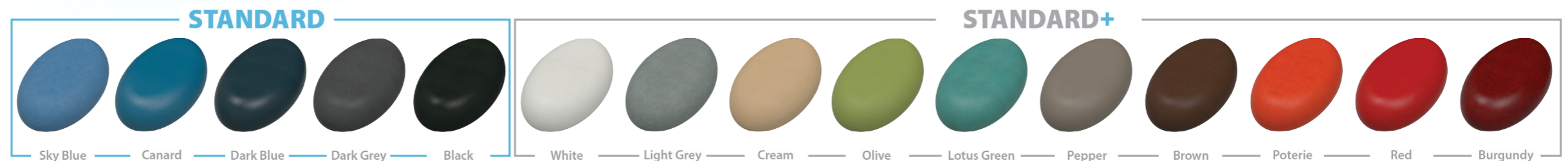

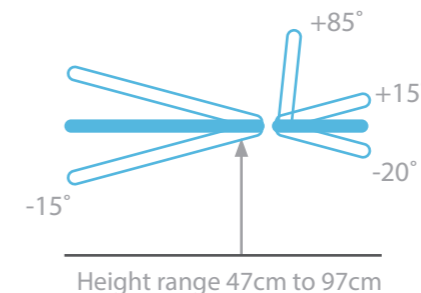

70* | 130 | 65

Innovation Deluxe 2 Section



The Innovation Deluxe 2 section couch is suitable for use within specialist critical care environments, endoscopy, ultrasound scanning and minor treatment procedures. Electric height, backrest and 2-way tilt ensure smooth transition when positioning patients for specialist procedures and treatments. Auto-electric CPR functionality and auto-levelling software return the couch quickly to a fully horizontal resuscitation position in the event of an emergency.

Models

- MG2475** Electric with electric backrest and 2-way tilt. Large independently locking wheel design
- MG2675** Electric with electric backrest and 2-way tilt. Large central locking wheel design with steering facility



Model MG2675 with large central locking wheel design with steering facility

Standard Features

- Electric height range from 47cm to 97cm
- Electric trendelenburg tilt to $-/+15^\circ$
- Electric backrest adjustable from -20° to $+85^\circ$
- Safe working load and lifting capacity of 250Kg (550lbs)
- Auto-electric CPR function via handset
- Auto-intelligent operation
- Vertical lifting design to minimise space and provide maximum stability throughout all profiling positions
- Smooth moulded base cover minimises dirt traps and facilitates easy cleaning
- Anti-bacterial powder coated frame and base cover
- Large TENTE[®] Ø125mm castors
- **SEERS ComfortPlus™** Upholstery - features anti-microbial vinyl incorporating pressure relieving design for additional patient comfort with a foam depth of 60mm
- 70cm wide upholstery
- Clearance beneath frame for mobile hoist
- Head Cushion & Paper Roll Holder fitted as standard
- Choice of Standard or Standard+ upholstery colours

Optional Accessories

- 6003** Side support rails (Pair)
- 9002P** Side support rail cushions (Pair)
- 6004** Breathing hole and plug
- 6006** Upper limb support
- 6054** Telescopic IV pole
- 6057** Battery back-up facility



Negative head section to -20°



Trendelenburg tilt to -15°

Available Upholstery Colours:

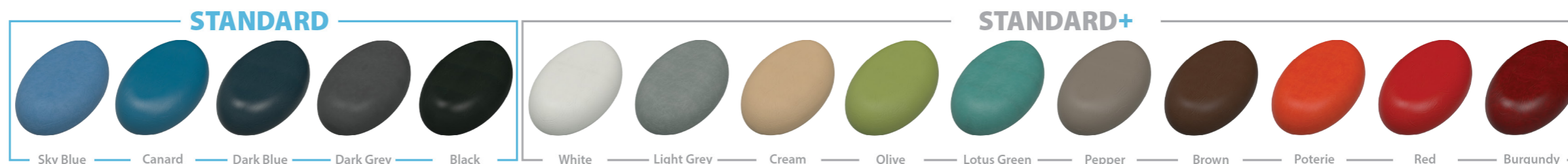

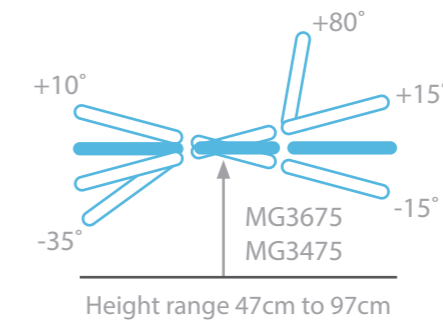

Innovation Deluxe 3 Section



The Innovation Deluxe 3 section couch is designed for use within specialist critical care environments. Electric height, backrest and foot section profiling and 2-way tilt ensure a smooth transition when positioning patients for specialist procedures and treatments. Auto-electric CPR functionality and auto levelling software return the couch quickly to a fully horizontal resuscitation position in the event of an emergency.

Models

- MG3475** Electric profiling of height, backrest and foot section with auto-levelling, 2-way tilt and CPR facility. Large independently braked wheel design
- MG3675** Electric profiling of height, backrest and foot section with auto-levelling, 2-way tilt and CPR facility. Large central locking wheel design with steering facility



Model MG3475 with large independently braked wheel design

Standard Features

- Electric height range from 47cm to 97cm
- Electric trendelenburg tilt to $-/+15^\circ$
- Electric backrest adjustable from 0° to $+80^\circ$
- Electric footrest adjustable from $+10^\circ$ to -35°
- Safe working load and lifting capacity of 250Kg (550lbs)
- Auto-electric CPR function via handset
- Auto-intelligent operation
- Vertical lifting design to minimise space and provide maximum stability throughout all profiling positions
- Smooth moulded base cover minimises dirt traps and facilitates easy cleaning
- Anti-bacterial powder coated frame and base cover
- Large TENTE[®] $\varnothing 125$ mm castors
- **SEERS ComfortPlus™** Upholstery - features anti-microbial vinyl incorporating pressure relieving design for additional patient comfort with a foam depth of 60mm
- 70cm Standard width upholstery
- Clearance beneath frame for mobile hoist
- Head Cushion & Paper Roll Holder fitted as standard
- Choice of Standard or Standard+ upholstery colours

Optional Accessories

- 6003** Side support rails (Pair)
- 9002P** Side support rail cushions (Pair)
- 6004** Breathing hole and plug for prone treatments
- 6006** Upper limb support
- 6054** Telescopic IV pole
- 6057** Battery back-up facility



Trendelenburg tilt to -15°



Low patient transfer height



Reverse trendelenburg tilt to $+15^\circ$

Available Upholstery Colours:

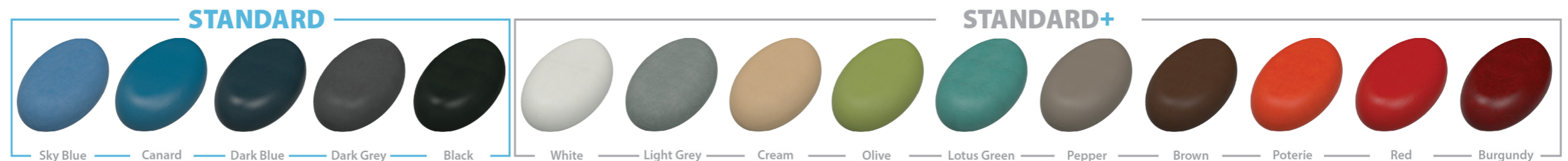

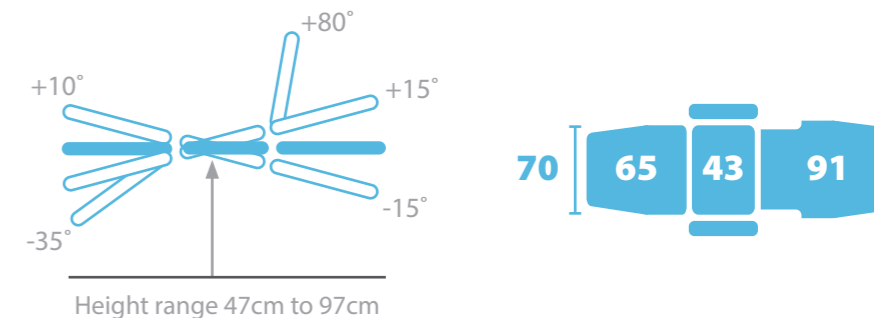

Innovation Deluxe Daycare



The Innovation Deluxe Daycare couch is designed for specialist medical procedures, critical care and oncology units. The fully electric functionality provides smooth lifting and patient profiling during patient examination and treatment. The couch features 2-way tilt and auto-electric CPR facility with auto-levelling software.

Models

- MG3493** Electric profiling of height, backrest and foot section with auto-levelling, 2-way tilt and CPR facility. Large independently braked wheel design
- MG3693** Electric profiling of height, backrest and foot section with auto-levelling, 2-way tilt and CPR facility. Large central locking wheel design with steering facility



2-way trendelenburg tilt facility to +/-15°



Model MG3693 with large central locking wheel design with steering facility

Standard Features

- Electric height range from 47cm to 97cm
- Electric trendelenburg tilt to +/-15°
- Electric backrest adjustable from 0° to +80°
- Electric footrest adjustable from +10° to -35°
- Safe working load and lifting capacity of 250Kg (550lbs)
- Auto-electric CPR function via handset
- Auto-intelligent operation
- Vertical lifting design to minimise space and provide maximum stability throughout all profiling positions
- Smooth moulded base cover minimises dirt traps and facilitates easy cleaning
- Anti-bacterial powder coated frame and base cover
- Large TENTE® Ø125mm castors
- **SEERS ComfortPlus™** Upholstery - features anti-microbial vinyl incorporating pressure relieving design for additional patient comfort with a foam depth of 60mm
- 70cm standard width upholstery
- Clearance beneath frame for mobile hoist
- Head Cushion, Paper Roll Holder, Side Rails and Side Support Cushions fitted as standard
- Fold down side rails and cushions provide patient comfort and security
- Choice of Standard and Standard+ upholstery colours

Optional Accessories

- 6054** Telescopic IV pole
- 6057** Battery back-up facility
- 6241** Patient lap tray
- 6242** Adjustable foot board



Model 6241 optional patient lap tray



Model 6242 optional adjustable foot board



Low patient transfer height

Available Upholstery Colours:

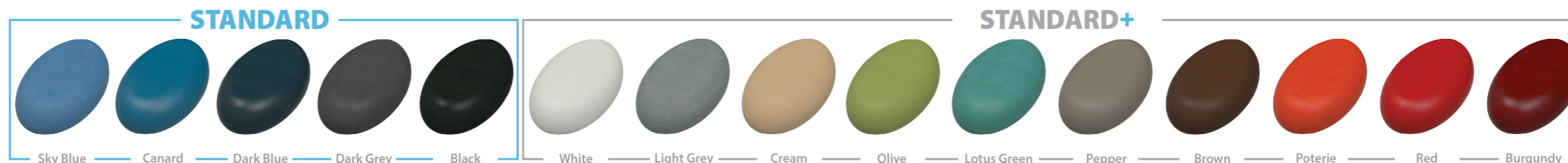

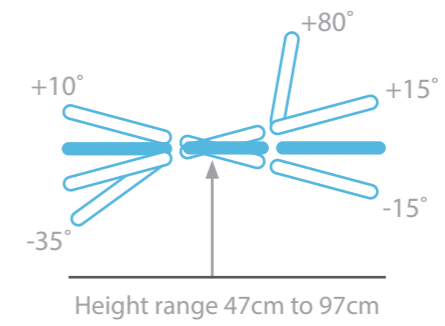

Innovation Deluxe Dialysis



The Innovation Deluxe Dialysis couch has been designed for use within specialist renal dialysis environments. The couch features auto-electric CPR and fully electric profiling with a 2-way tilt facility to ensure a smooth transition when positioning patients for dialysis procedures and treatments.

Models

- MG3490** Electric profiling of height, backrest and foot section with auto-levelling, 2-way tilt and CPR facility. Large independently braked wheel design
- MG3690** Electric profiling of height, backrest and foot section with auto-levelling, 2-way tilt and CPR facility. Large central locking wheel design with steering facility



Model MG3490 with large independently braked wheel design

Standard Features

- Electric height range from 47cm to 97cm
- Electric trendelenburg tilt to $\pm 15^\circ$
- Electric backrest adjustable from 0° to $+80^\circ$
- Electric footrest adjustable from $+10^\circ$ to -35°
- Safe working load and lifting capacity of 250Kg (550lbs)
- Auto-electric CPR function via handset
- Auto-intelligent operation
- Vertical lifting design to minimise space and provide maximum stability throughout all profiling positions
- Smooth moulded base cover minimises dirt traps and facilitates easy cleaning
- Anti-bacterial powder coated frame and base cover
- Large TENTE[®] $\varnothing 125\text{mm}$ castors
- **SEERS ComfortPlus™** Upholstery - features anti-microbial vinyl incorporating pressure relieving design for additional patient comfort with a foam depth of 60mm
- 70cm standard width upholstery
- Clearance beneath frame for mobile hoist
- Head Cushion & Paper Roll Holder fitted as standard
- Multi-adjustable arm rests and adjustable upholstered foot board included for patient comfort
- Choice of Standard and Standard+ upholstery colours

Optional Accessories

- 6054** Telescopic IV pole
- 6057** Battery back-up facility
- 6241** Patient lap tray



Low patient transfer height



2-way trendelenburg tilt facility to $\pm 15^\circ$



Fully profiled for patient comfort

Available Upholstery Colours:

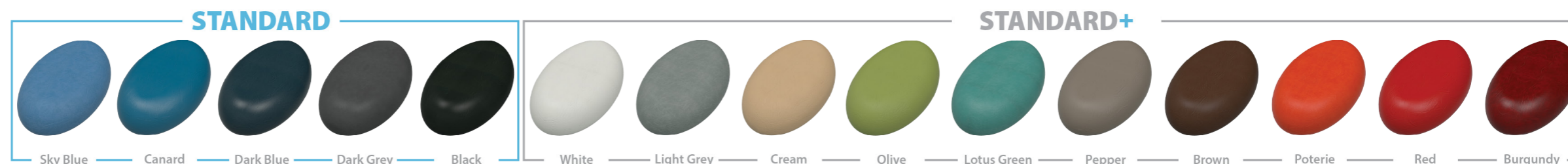

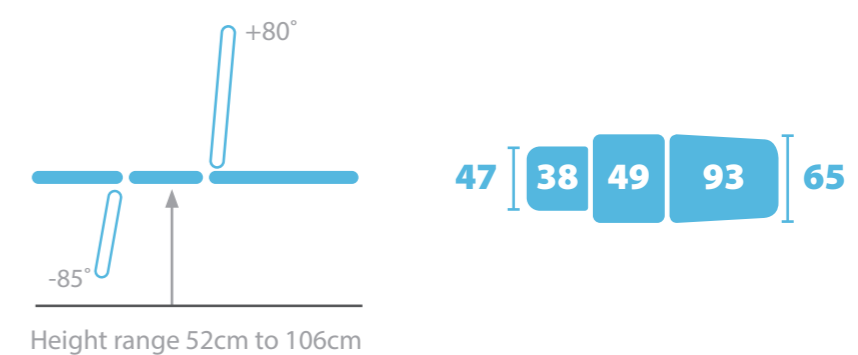

Medicare Multi-Couch



Incorporating both an adjustable angle backrest and a single drop end foot section, these models are suitable for a wide range of seated and supine patient examination procedures. The slightly narrow foot section enables the addition of leg supports or stirrups for gynaecological procedures.

Models

- SM9556 Hydraulic with gas assisted backrest
- SM9566 Electric with gas assisted backrest
- SM9576 Electric with electric backrest



Model SM9566
Colour Light Grey



Model 6045 optional leg supports for gynaecology
Colour may differ from above image

Standard Features

- Safe working load and lifting capacity of 240Kg (528lbs)
- Gas assisted or electric backrest adjustable from 0° to +80°
- Gas assisted foot section adjustable from 0° to -85°
- Gas assisted sections incorporate an anti-trap design
- Choice of hydraulic or electric height elevation
- Excellent height range from 52cm to 106cm
- Compact frame design with retractable wheel system
- Adjustable foot for stability on uneven surfaces
- Purpose made precision bearings on all pivot points
- Anti-bacterial powder coated frame
- Clearance beneath frame for mobile hoist
- Hand switch fitted as standard on electric models
- 65cm standard width upholstery
- Choice of Standard and Standard+ upholstery colours

Optional Accessories

- 6004 Breathing hole and plug
- 6005 Paper roll holder
- 6006 Upper limb support
- 6007 Removable head/knee cushion
- 6044 Lithotomy stirrups
- 6045 Leg supports for gynaecology
- 6052 Protective base frame cover
- 6054 Telescopic IV pole
- 6057 Battery back-up facility
- 1WF Single foot switch for SM9566
- 2WF Double foot switch for SM9576



Low patient transfer height



Model 6044 optional lithotomy stirrups

Available Upholstery Colours:

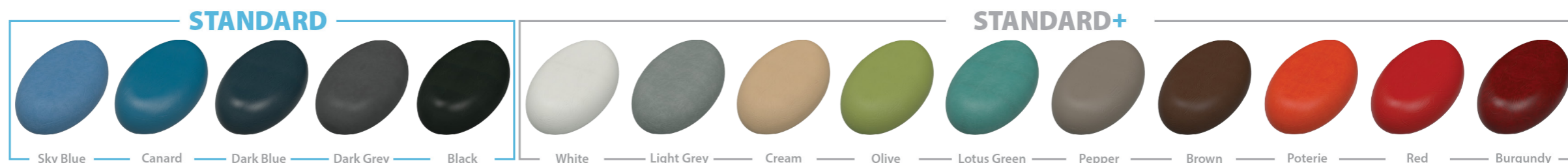

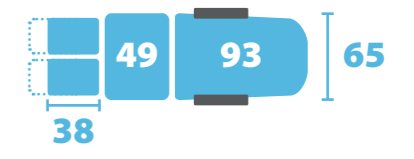
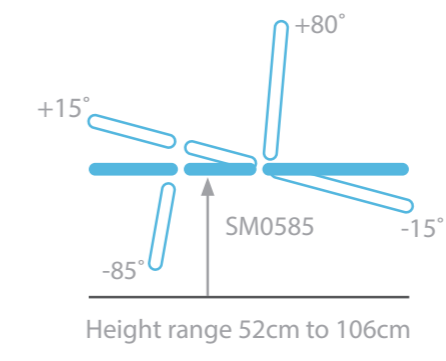
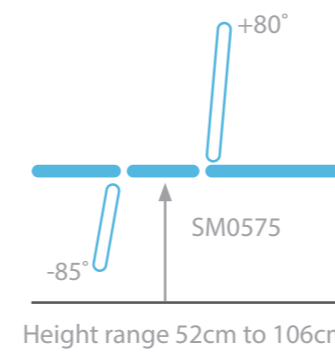

Medicare Podiatry Couch



Incorporating both an adjustable angle backrest with patient armrests and dual adjustable footrests, these models are suitable for a wide range of seated examination procedures such as podiatry, leg ulcer clinics, orthopaedic casting (plaster room), as well as being ideal for GP surgeries and health centres.

Models

- SM0575** Electric height and backrest
- SM0585** Electric height, tilt and backrest



6004 Breathing hole and plug for prone treatments



Model SM0585
Shown with optional 6053 Base Cover.
Colour Sky Blue



Low patient transfer height

Standard Features

- Safe working load and lifting capacity of 240Kg (528lbs)
- Electric backrest adjustable from 0° to +80°
- Gas assisted foot sections adjustable from 0° to -85° and incorporate anti-trap design gas struts
- Footrests extend for tall patients
- Fold-down armrests have angular adjustment
- Electric height elevation via hand control
- Excellent height range from 52cm to 106cm
- SM0585 includes paper roll holder and matching headrest as standard
- Electric tilt facility of -15° on SM0585
- Compact frame design with retractable wheel system
- Adjustable foot for stability on uneven surfaces
- Purpose made precision bearings on all pivot points
- Anti-bacterial powder coated frame
- Clearance beneath frame for mobile hoist
- 65cm standard width upholstery
- Choice of Standard or Standard+ upholstery colours

Optional Accessories

- 6052** Protective base frame cover
- 6007** Head Cushion (Included on SM0585)
- 6005** Paper roll holder (Included on SM0585)
- 6004** Breathing hole and plug
- 6054** Telescopic IV Pole Attachment
- 6057** Battery back-up facility
- 2WF** Double foot switch for SM0575
- 3WF** Triple foot switch for SM0585



Matching headrest as standard on Model SM0585. Option on Model SM0575

Available Upholstery Colours:

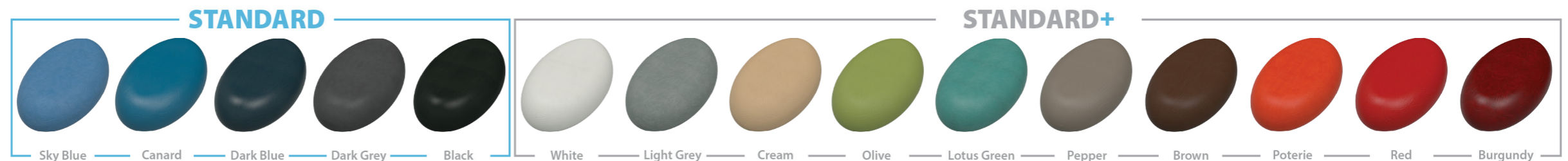

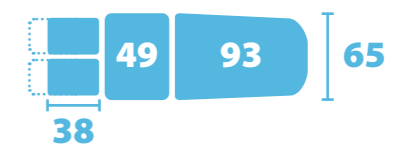
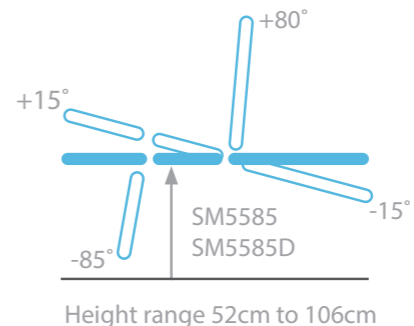
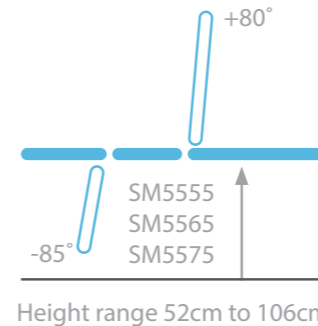

Medicare Orthopaedic Couch



Designed specifically for plaster casting technicians, this couch features individually adjustable leg sections and is available with a range of optional accessories to assist and support the technician in carrying out various casting procedures. The Deluxe version is supplied as a package with base shroud, set of accessories and matching stool.

Models

- SM5555** Hydraulic with gas assisted backrest
- SM5565** Electric with gas assisted backrest
- SM5575** Electric with electric backrest
- SM5585** Electric with electric height, tilt and backrest
- SM5585D** Deluxe model with stool, base cover and Orthopaedic accessories set

Model SM5565
Shown with ST6103 Operators Stool
Colour Dark Blue



Standard Features

- Safe working load and lifting capacity of 240Kg (528lbs)
- Gas assisted or electric backrest adjustable from 0° to +80°
- Gas assisted foot sections adjustable from 0° to -85°
- Trendelenburg tilt to -15° on Models SM5585/ SM5585D
- Gas assisted sections incorporate anti-trap design
- Footrests extend for tall patients
- Choice of hydraulic or electric height elevation
- Excellent height range from 52cm to 106cm
- Compact frame design with retractable wheel system
- Adjustable foot for stability on uneven surfaces
- Purpose made precision bearings on all pivot points
- Anti-bacterial powder coated frame
- Clearance beneath frame for mobile hoist
- Hand switch fitted as standard on electric models
- 65cm standard width upholstery
- Choice of Standard and Standard+ upholstery colours

Optional Accessories

- 5006** Orthopaedic arm support
- 5007** Orthopaedic full leg seat module
- 5008** Knee support roll set
- 5009** Orthopaedic leg support attachment
- 6004** Breathing hole and plug
- 6005** Paper roll holder
- 6007** Removable head/knee cushion
- 6052** Protective base frame cover
- 6057** Battery back-up facility
- 1WF** Single foot switch for SM5565
- 2WF** Double foot switch for SM5575
- 3WF** Triple foot switch for SM5585/SM5585D



5007
Orthopaedic Full Leg
Seat Module



5006
Orthopaedic Arm Support



5009
Orthopaedic Leg Support Attachment



5008
Knee Support Roll Set



Model SM5565 showing
extended patient footrest

Available Upholstery Colours:

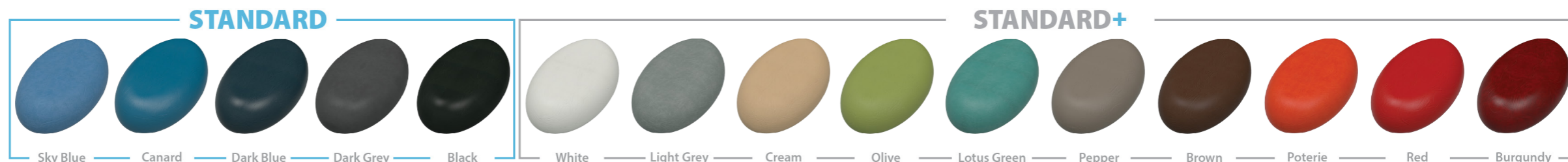

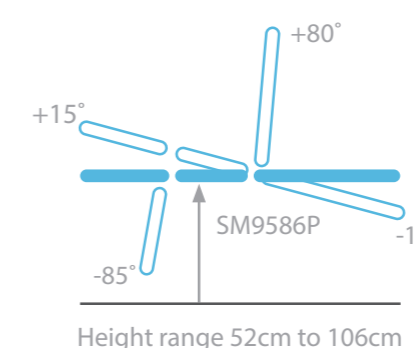
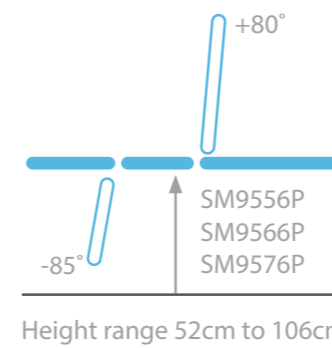

Medicare Phlebotomy Couch



A specialist couch designed to provide a comfortable and easy to mount seat position for blood sampling procedures. All models are fitted with a pair of multi-adjustable arm rests and side support loops for the stability and safety of the patient when mounting and dismounting the couch. The seat section is inclined for additional patient security.

Models

- SM9556P** Hydraulic with gas assisted backrest
- SM9566P** Electric with gas assisted backrest
- SM9576P** Electric with electric backrest
- SM9586P** Electric height, tilt and backrest



Model SM9566P
Colour Dark Blue

Standard Features

- Safe working load and lifting capacity of 240Kg (528lbs)
- Gas assisted or electric backrest adjustable from 0° to +80°
- Electric Trendelenburg tilt to -15° on SM9586P
- Patient hand-grip supports to aid mount/dismount from the couch as well, as providing patient security
- Fully adjustable arm supports for use on either side of couch
- Paper roll holder fitted as standard
- Choice of hydraulic or electric height elevation
- Excellent height range from 52cm to 106cm
- Compact frame design with retractable wheel system
- Adjustable foot for stability on uneven floors
- Purpose made precision bearings on all pivot points
- Anti-bacterial powder coated frame
- Inclined seat section encourages patients to sit back
- Clearance beneath frame for mobile hoist
- Hand switch fitted as standard on electric models
- 65cm standard width upholstery
- Choice of Standard or Standard+ upholstery colours

Optional Accessories

- 6052** Protective base frame cover
- 6057** Battery back-up facility
- 6007** Head cushion (Included on SM9586P)
- 1WF** Single foot switch for SM9566P
- 2WF** Double foot switch for SM9576P
- 3WF** Triple foot switch for SM9586P

Low Patient Transfer Height



ST6101
Operators Chair (High Model)



Available Upholstery Colours:

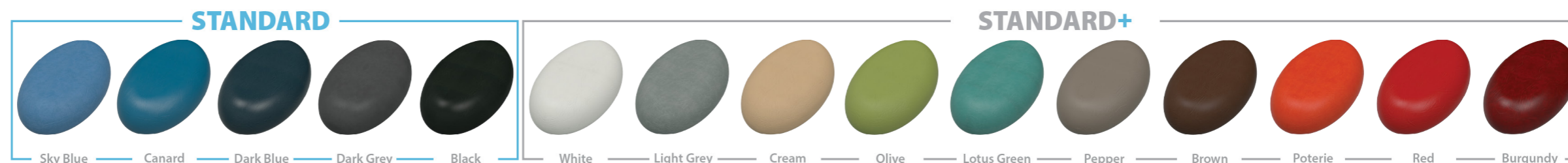

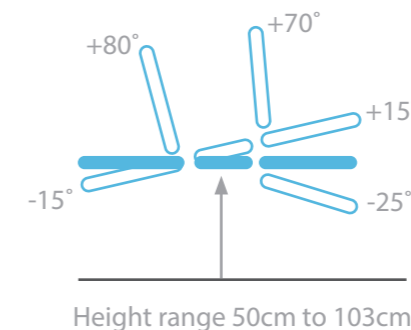

Medicare Echocardiography Couch



Designed specifically for Echocardiography, this couch has electric operation of height, tilt and backrest angle. The backrest has a cut-away design for improved application of the transducer during scanning procedures and a specially designed stool for the clinician is also provided. The couch is also supplied with an integral footrest for the clinician, as well as a patient hand-grip and head cushion for the patients comfort and security.

Models

- SM3590** Electric height, tilt and backrest. Retractable wheel system
- SM3690** Electric height, tilt and backrest. Central locking wheel system



Model SM3590
Colour Sky Blue

Standard Features

- Safe working load and lifting capacity of 240Kg (528lbs)
- Electric height, tilt and backrest adjustment
- Excellent height range from 50cm to 103cm
- Electric backrest adjustable from 0° to +80°
- Electric trendelenburg tilt to -15°
- Gas assisted foot section adjustable from -25° to +70°, incorporating anti-trap design
- Ergonomic backrest designed for improved transducer positioning
- Integral footrest for clinician when traditional right-hand scanning, together with specially designed stool
- Hand-grip and side support with cushion for patient positioning and security
- Purpose made precision bearings on all pivot points
- Anti-bacterial powder coated frame
- 65cm standard width upholstery
- Paper Roll Holder and Head Support Cushion fitted as standard
- Retractable wheel design with adjustable foot for stability on uneven surfaces
- Choice of Standard and Standard+ upholstery colours

Optional Accessories

- 3WF** Triple foot switch operation
- 6057** Battery back-up facility
- 6123** Fully adjustable arm support for the clinician



Special design stool provided for clinician, included as standard



Model SM3590 with Tilt applied and backrest adjusted to ~30°



Model 6123 optional adjustable arm support for clinician

Available Upholstery Colours:

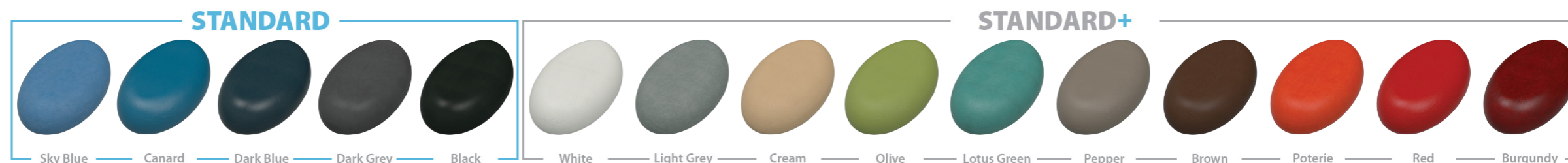

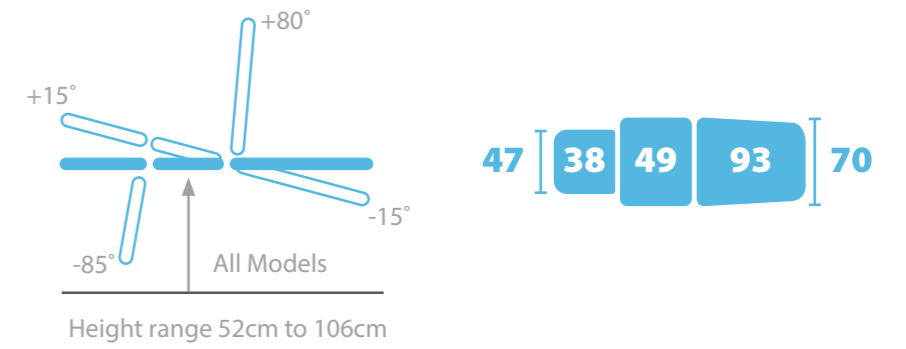

Medicare Ultrasound Couch



Providing smooth electric positioning of height, tilt and backrest angle, these couches feature a compact base frame and are ideal for both supine and seated procedures. The deluxe model includes the base frame cover and matching operators chair. The narrower foot section enables the fitting of optional leg supports or stirrups for gynaecological procedures.

Models

- SM9686** Electric height, tilt and backrest, gas assisted foot section
- SM9686D** Deluxe Model with Base Cover & Operators Chair
- SM9696** Electric height, tilt, backrest and foot section
- SM9696D** Deluxe Model with Base Cover & Operators Chair



Model SM9686
Shown with 6045 Gynaecology Leg Supports.
(Colour may differ)
Colour Light Grey



Model 6044 optional lithotomy stirrups

Standard Features

- Safe working load and lifting capacity of 240Kg (528lbs)
- Electric adjustment of height, tilt, backrest and foot section
- Electric backrest adjustable from 0° to +80°
- Adjustable angle footrest from 0° to -85°
- Electric trendelenburg angle to -15°
- Choice of gas assisted or electric operated foot section
- Excellent height range from 52cm to 106cm
- Paper Roll Holder and Head Cushion fitted as standard
- Compact frame design with retractable wheel system
- Adjustable foot for stability on uneven surfaces
- Purpose made precision bearings on all pivot points
- Anti-bacterial powder coated frame
- Clearance beneath frame for mobile hoist
- 70cm standard width upholstery
- Choice of Standard and Standard+ upholstery colours

Optional Accessories

- 6004** Breathing hole and plug
- 6041** Side support loops
- 6044** Lithotomy Stirrups
- 6045** Gynaecology Leg Supports
- 6052** Protective base frame cover
- 6054** Telescopic IV pole
- 6057** Battery back-up facility
- 3WF** Triple foot switch for SM9686/SM9686D
- 4WF** Quad foot switch for SM9696/SM9696D



MC6158
Surgeons & Sonographers Chair



Model SM9686 in trendelenburg position

Available Upholstery Colours:

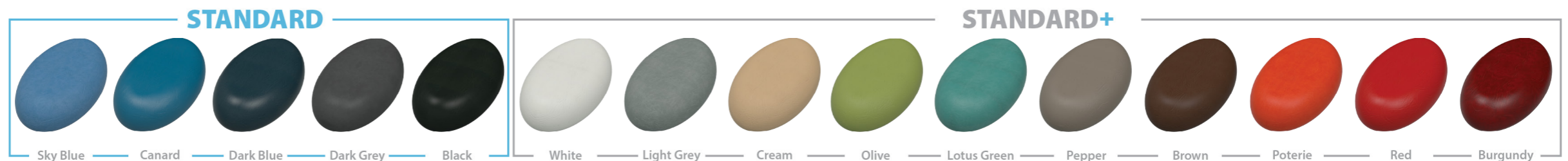

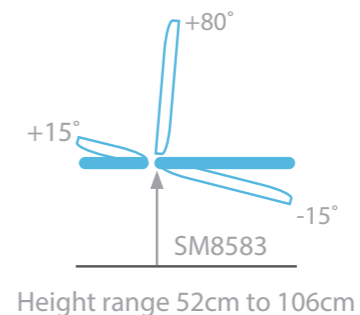
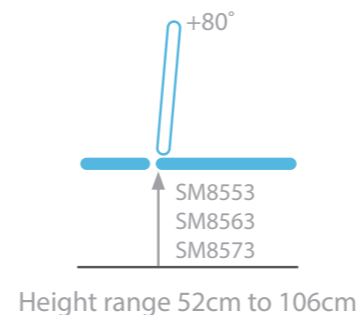

Medicare Gynaecology Couch



Designed for general gynaecology procedures, these models are available with either hydraulic or electric height operation and feature a wide choice of optional accessories to meet both financial and clinical requirements. All models feature a crescent shaped seat design and are supplied with fully adjustable leg supports, paper roll holder, side support loops and debris tray for gynaecology procedures.

Models

- SM8553** Hydraulic with gas assisted backrest
- SM8563** Electric with gas assisted backrest
- SM8573** Electric height and backrest
- SM8583** Electric height, tilt and backrest



6043
Removable Leg Extension

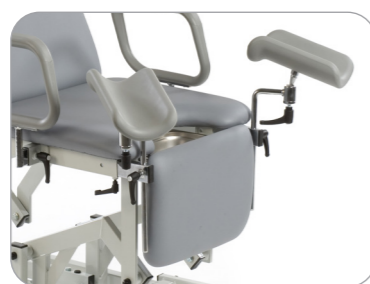

6051
Fold-Down Leg Extension



Model SM8583
Colour Dark Blue

Standard Features

- Safe working load and lifting capacity of 240Kg (528lbs)
- Electric backrest adjustable from 0° to +80°
- Crescent shaped seat design
- Fully adjustable patient leg supports
- Fitted with debris tray, Side Loops & Paper Roll Holder
- Choice of hydraulic or electric height elevation
- Excellent height range from 52cm to 106cm
- Compact base with retractable wheel system
- Adjustable foot for stability on uneven floors
- Purpose made precision bearings on all pivot points
- Anti-bacterial powder coated frame
- Hand switch fitted as standard on electric models
- Electric trendelenburg tilt to -15° on model SM8583
- 65cm standard width upholstery
- Choice of Standard and Standard+ upholstery colours

Optional Accessories

- 6007** Head Cushion *(Included on SM8583)*
- 6043** Removable leg extension accessory
- 6051** Fold-down leg extension accessory
- 6052** Protective base frame cover
- 6057** Battery back-up facility
- 1WF** Single foot switch for SM8563
- 2WF** Double foot switch for SM8573
- 3WF** Triple foot switch for SM8583



ST6100
Operators Chair



Model SM8563 Colour light grey

Available Upholstery Colours:

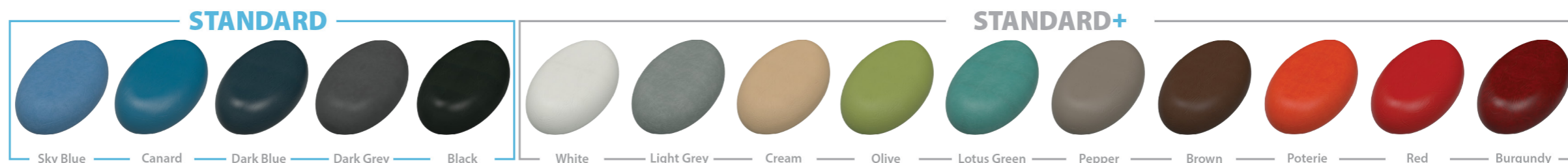

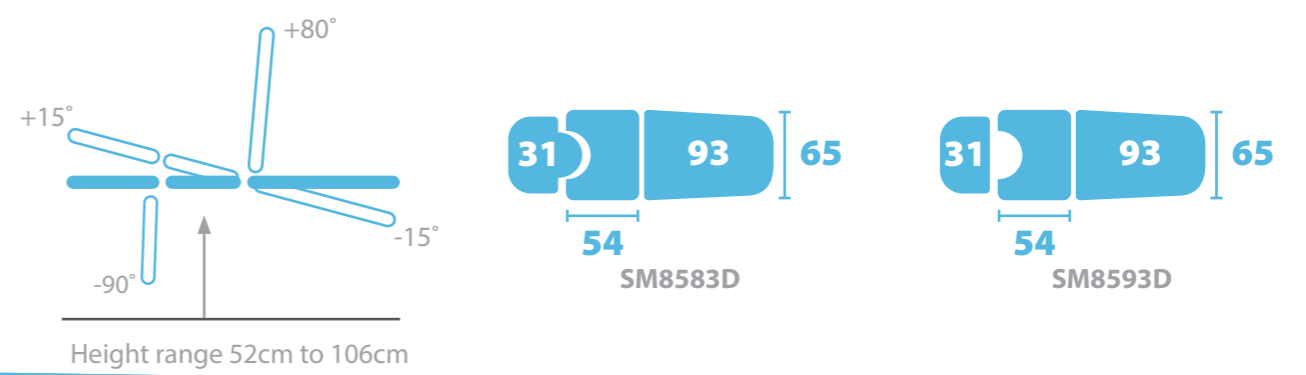

Medicare Deluxe Gynaecology Couch



Designed for colposcopy and general gynaecology procedures, these Deluxe models feature electric positioning for height, backrest angle and tilt position. They are supplied with a special set of accessories which include a matching operator's chair, base frame cover, a choice of leg extension, leg supports, matching head support cushion, side support loops, debris tray and paper roll holder.

Models

- SM8583D** Deluxe Model with removable extension
- SM8593D** Deluxe Model with fold-down extension



Model SM8583D
Colour Cream

Standard Features

- Safe working load and lifting capacity of 240Kg (528lbs)
- Electric backrest adjustable from 0° to +80°
- Electric control of height, backrest and tilt angle
- Excellent height range from 52cm to 106cm
- Crescent shaped seat design
- Fully adjustable patient leg supports
- Fitted with debris tray, Side Support Loops and Paper Roll Holder
- Supplied with operators chair, head cushion and base frame cover
- Choice of Removable or Fold-Down Leg Extension
- Compact base frame with retractable wheel system
- Adjustable foot for stability on uneven floors
- Purpose made precision bearings on all pivot points
- Anti-bacterial powder coated frame
- Hand switch fitted as standard
- 65cm standard width upholstery
- Choice of Standard and Standard+ upholstery colours

Optional Accessories

- 3WF Triple foot switch
- 6057 Battery back-up facility



Fold-down leg extension



Model SM8593D
Colour Sky Blue

Available Upholstery Colours:

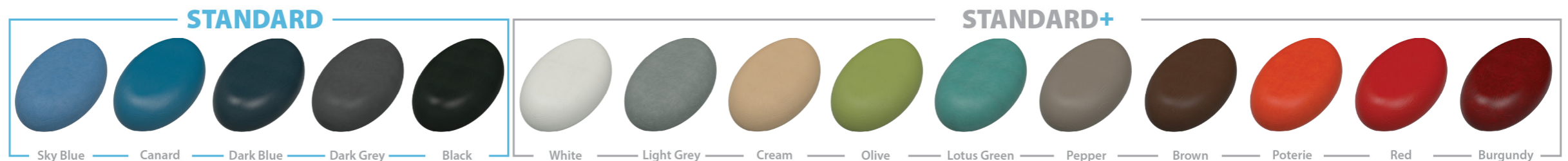

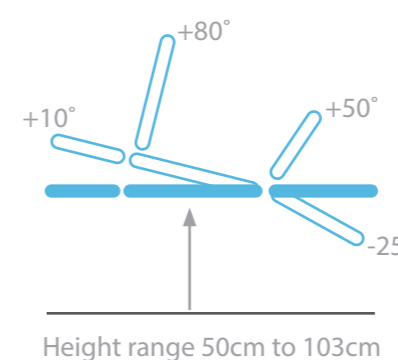

Medicare GP Gynaecology Couch



A multi-purpose couch providing electric positioning for gynaecology procedures, as well as a full length couch surface for most general prone and supine examinations and minor treatment procedures.

Models

- SM8543** Electric height, tilt and backrest with manual head section, retractable wheel system
- SM8543D** Deluxe Model complete with base cover, matching operators chair and head support cushion, retractable wheel system



ST6100
Operators Chair



Model SM8543
Colour Black

Standard Features

- Safe working load and lifting capacity of 240Kg (528lbs)
- Electric adjustable angle backrest from horizontal to +80°
- Electrically adjustable seat angle with trendelenburg to -10°
- Gas assisted head section adjustable from -25° to +50°
- Breathing hole and plug fitted as standard
- Excellent height range from 50cm to 103cm
- Retractable wheels with adjustable foot for uneven surfaces
- Clearance beneath frame for mobile hoist
- Anti-bacterial powder coated frame
- Supplied complete with lithotomy stirrups and debris tray
- Paper roll holder fitted as standard
- 70cm standard width upholstery
- Choice of Standard and Standard+ upholstery colours

Optional Accessories

- 6007** Head support cushion
- 6045** Gynaecology leg supports
- 6053** Protective base frame cover
- 6057** Battery back-up facility
- 3WF** Triple foot switch

Trendelenburg tilt to -10°.
Shown with 6045 Gynae Leg Supports



Available Upholstery Colours:

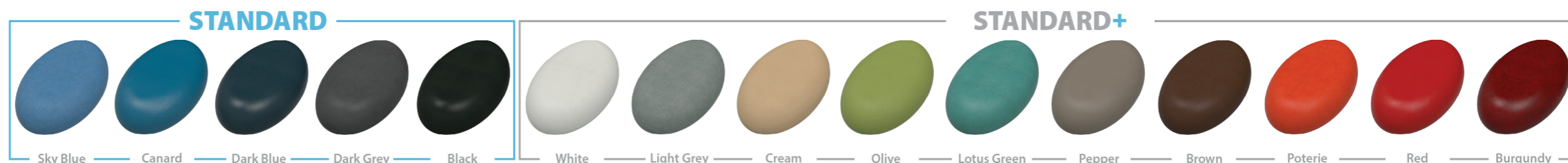

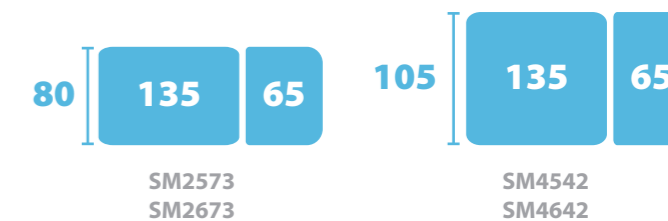
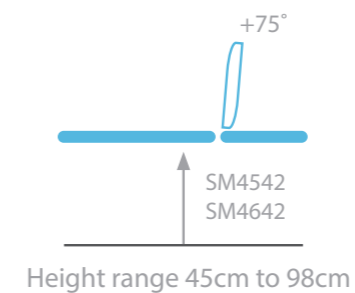
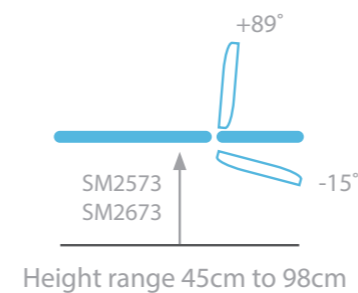

Medicare Bariatric 2 Section Couch



The Bariatric 2 Section Couches feature electric height and backrest operation for effortless patient positioning for various medical examinations and treatment procedures. There is a choice of widths available - Models SM2573 and SM2673 are available with a width of 80cm and Models SM4542 and SM4642 which have a wide frame, are available at 105cm as standard. All couches provide a safe working load and lifting capacity of 325Kg (715lbs).

Models

- SM2573** Electric with electric backrest 80cm wide. Retractable wheel system
- SM2673** Electric with electric backrest 80cm wide. Central Locking Castors
- SM4542** Electric with electric backrest 105cm wide. Retractable wheel system
- SM4642** Electric with electric backrest 105cm wide. Central Locking Castors

Standard Features

- Safe working load and lifting capacity of 325Kg (715lbs)
- Choice of retractable wheels or central locking castors
- Electric backrest adjustable from -15° to +89°
- Electric height elevation from 45cm to 98cm
- Purpose made precision bearings on all pivot points
- Anti-bacterial powder coated frame
- Clearance beneath frame for mobile hoist
- Choice of 80cm or 105cm width upholstery
- Hand switch fitted as standard
- Choice of Standard and Standard+ upholstery colours

Optional Accessories

- 6004** Breathing hole and plug
- 6005** Paper roll holder
- 6074** Side support rail (Pair)
- 9002P** Side support rail cushions (Pair)
- 6076** Memory foam upholstery (60mm)
- 2WF** Double foot switch



Model SM4542

Shown with 6074 Side Rails and 9002P Side Cushions



Model SM2573
Colour Dark Blue



Model SM4642
Colour Sky Blue

Available Upholstery Colours:

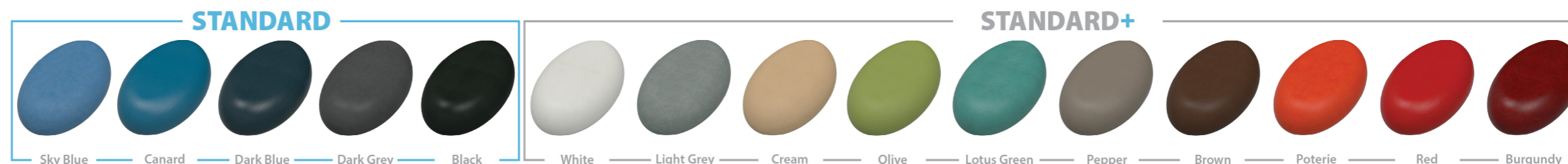

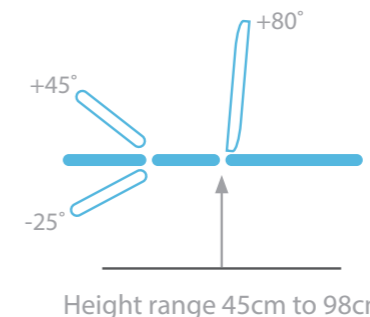

Medicare Bariatric 3 Section Couch



The Bariatric 3 Section Couch features electric height, backrest and foot section operation for effortless patient positioning for a wide range of examination procedures. There is a choice of wheel system available and the couch provides a safe working load and lifting capacity of 325Kg (715lbs).

Models

- SM3573** Electric with electric backrest and foot section. Retractable wheel system
- SM3673** Electric with electric backrest and foot section. Central locking wheel system



Model SM3573
Colour Light Grey

Standard Features

- Safe working load and lifting capacity of 325Kg (715lbs)
- Choice of retractable wheel or large wheel design, with central locking & steering facility
- Electric footrest adjustable from -25° to +45°
- Electric backrest adjustable from 0° to +80°
- Electric height elevation from 45cm to 98cm
- Purpose made precision bearings on all pivot points
- Anti-bacterial powder coated frame
- Clearance beneath frame for mobile hoist
- 80cm standard width upholstery
- Hand switch fitted as standard
- Choice of Standard and Standard+ upholstery colours

Optional Accessories

- 6005** Paper roll holder
- 6007** Head support cushion
- 6073** Side support rails (Pair)
- 9002P** Side Cushions (Pair)
- 6076** Memory foam upholstery (60mm)
- 3WF** Triple Foot Switch

Low patient transfer height



Model SM3573
Colour Light Grey

Available Upholstery Colours:

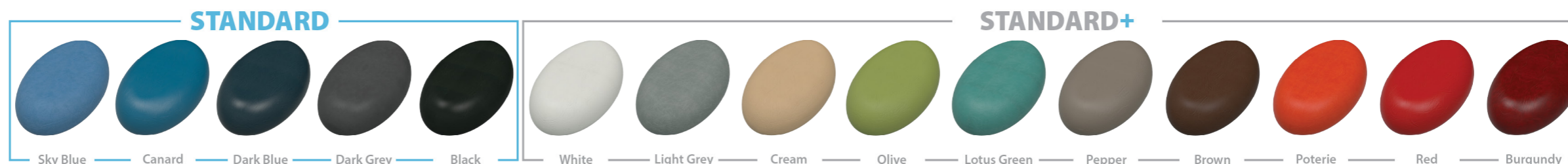

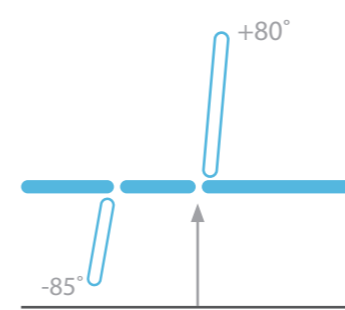

Height range 50cm to 105cm

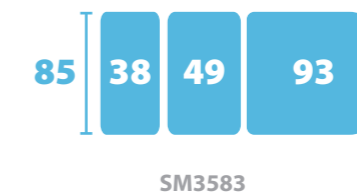

SM3583

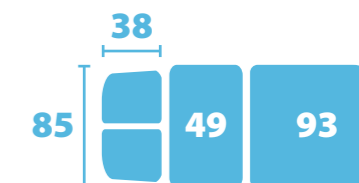

SM3584

Medicare Bariatric Drop End Couch



The Bariatric Drop End Couches feature electric independently operated foot sections for effortless positioning for various lower limb procedures. The electric backrest supports the patient in the sitting position. There is a choice of models with either single or dual foot sections, all with a safe working load and lifting capacity of 325Kg (715lbs).

Models

- SM3583** Electric height, backrest and single foot section
- SM3584** Electric height, backrest and dual foot sections



Model SM3584
Colour Dark Grey

Standard Features

- Safe working load and lifting capacity of 325Kg (715lbs)
- Memory foam upholstery (60mm) for additional patient comfort
- Retractable wheel design with adjustable foot for stability
- Electric backrest adjustable from 0° to +80°
- Electric foot section(s), adjustable from 0° to -85°
- Electric height elevation from 50cm to 105cm
- Purpose made precision bearings on all pivot points
- Anti-bacterial powder coated frame
- Clearance beneath frame for mobile hoist
- Hand switch fitted as standard
- 85cm standard width upholstery
- Choice of Standard and Standard+ upholstery colours

Optional Accessories

- 6005** Paper roll holder
- 6007** Head support cushion
- 6041** Side support loops (Pair)
- 6073** Side support rails (Pair)
- 9002P** Side support rail cushions (Pair)
- 3WF** Triple foot switch for SM3583
- 4WF** Quad foot switch for SM3584



Dual Adjustable Electric Footrests on SM3584

Model SM3583
Colour Dark Blue.



Available Upholstery Colours:

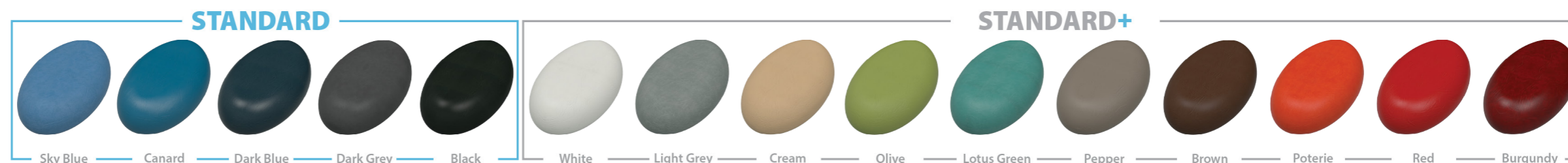

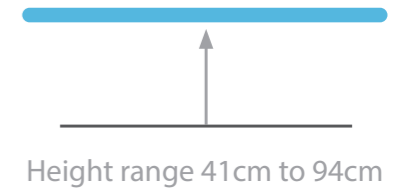
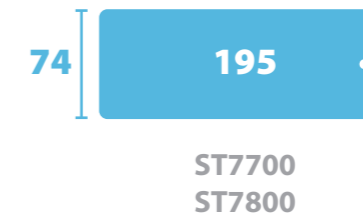
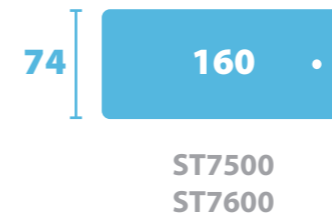

Shower Trolley



Designed to provide transport to and from the showering area, these mobile Shower Trolley models feature a foam padded PVC liner for added patient comfort, a linked wheel system with central locking and steering facility, as well as fold down side support rails for patient transfer. The Junior model has an overall length of 160cm and both the Standard and Junior models are available with a rechargeable battery option as an alternative to the hydraulic height operation.

Models

ST7700	Standard hydraulic
ST7800	Electric with Rechargeable battery
ST7600	Junior hydraulic
ST7500	Junior electric with Rechargeable battery

Model ST7700
Patient Transfer Height with
Side & Foot Rails folded down



Standard Features

- Safe working load and lifting capacity of 240Kg (528lbs)
- 125mm central locking wheel design, with and steering facility
- Hydraulic height adjustment 41cm to 94cm via foot pedal
- Rechargeable battery models 41cm to 94cm via hand switch
- Battery operated models include a spare battery pack and charging unit
- Foam padded PVC liner with side supports and end panels for comfort and security
- Supplied with foam padded PVC patient support cushion
- Side support rails fold down to assist patient transfer
- Low gradient tilt towards foot end for water drainage via integral waste outlet
- Plug and drain hose supplied complete with storage bracket
- Bumpers fitted to all corners for protection during transport procedures
- Bumpers can be removed to reduce the width to 65cm to access tight doorways
- Lowers to wheelchair height for ease of patient transfer
- Purpose made precision bearings on all pivot points
- Clearance beneath frame for mobile hoist
- Choice of junior or standard models



Model ST7800



Charger unit

Optional Accessories



-1WF

Single foot switch option (alternative to standard single hand switch).



-2WF

Double foot switch option (alternative to standard double hand switch).

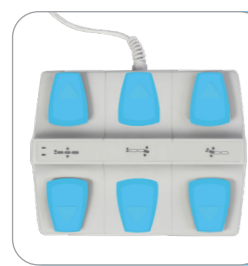

-3WF

Triple foot switch option (alternative to standard triple hand switch).



-EFPS

The perimeter foot switch is a "hands free" foot operated system for height adjustment. Medicare 2 & 3 sections only.



6057

Battery back-up available for most electric operated models.



6052 & 6053

An easy to clean protective base frame cover that conceals the moving parts of the framework.



6002 & 6003

Fold-down side support rails for 2 & 3 section couches, providing patient support and security.

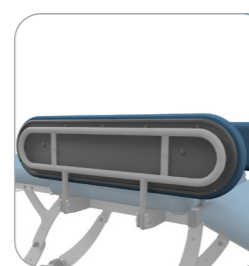

9002P

Upholstered cushions can be added to the side support rails for additional comfort, support and protection.



6041

Side support loops provide patient support and security and are easily removable.



6054

Telescopic IV pole has fixing points on both sides of the couch and is easily adjusted to the required height.



6005

The paper roll holder provides a protective barrier between the patient and the upholstered surface.



6004

Breathing hole & plug for improved patient comfort for prone treatments.



6007

The head support cushion is easily attached to the couch and can also be used as a support for lower limbs.



6006

The upper limb support has multi-angular adjustment and can be fitted to either side of the couch.



5008

The knee roll support set is an ideal accessory for supporting limbs during medical procedures.



6020

A light weight free-standing adjustable leg support for lower limb procedures. Supplied with carrying case.



6044

Traditional lithotomy stirrups for gynaecology procedures.



6045

Leg supports for gynaecology procedures. Fully adjustable for patient comfort and security.

If you have any queries on any of the optional accessories listed above please contact us for further details. Please note some of the accessories are supplied as standard with specific couches so please ensure you check before purchasing your chosen product as all other options come at an additional cost.

Chairs & Stools



MC6158
Surgeons / Sonographers chair, standard model. Height range of 45-59cm. Polished aluminium gas strut, five star base and castors.



MC6178
Round general medical chair, standard model. Height range of 45-59cm. Polished aluminium gas strut, five star base and castors.



ST6100
Standard operators chair with 2 lever operation for height and backrest angle. Height range of 48-60cm. Black five star base and castors.



ST6101
High operators chair with 2 lever operation for height and backrest angle. Height range of 53-73cm. Adjustable foot support ring. Black five star base and glides.



ST6103
Standard operators stool with all round release lever for height adjustment with range of 48-60cm. Black five star base and castors.



ST6104
High operators stool with all round release lever for height adjustment with range of 53-73cm. Adjustable foot support ring. Black five star base and glides.



ST6144
Economy saddle stool with single lever height adjustment with a range of 48-60cm. Black five star base and castors.



MC6107
Deluxe saddle chair with 2 lever operation for height and seat tilt facility. Height range of 54-71cm. Polished aluminium five star base and castors.

Note¹: See Medical Seating brochure for more options.

Mundial Standard Range

A range of globally popular, hard-wearing vinyl colours that will retain performance for many years. Abrasion Resistance to 150,000 cycles. Available as standard on all upholstered couches and seating products.



Mundial Standard+ Range*

A selection of unique coloured, hard-wearing vinyl colours that will retain performance for many years. Abrasion Resistance to 150,000 cycles.

* Available at an additional cost for all Clinical Range Couches, excluding Shower Trolleys.



Other colours are available on request

Please Note: The illustrated vinyl colours may vary slightly from actual vinyl supplied. This occurs due to the four colour printing process, however every attempt has been made to make them as accurate as possible.